

SYNERGY RANGE OF RIGID INFLATABLE BOATS



SYNERGY EQUIPMENT TRADING LLC.
 SOLUTION F.Z.C.
 WATER

SYNERGY RANGE OF RIGID INFLATABLE BOATS



SYNERGY RANGE OF RIGID INFLATABLE BOATS

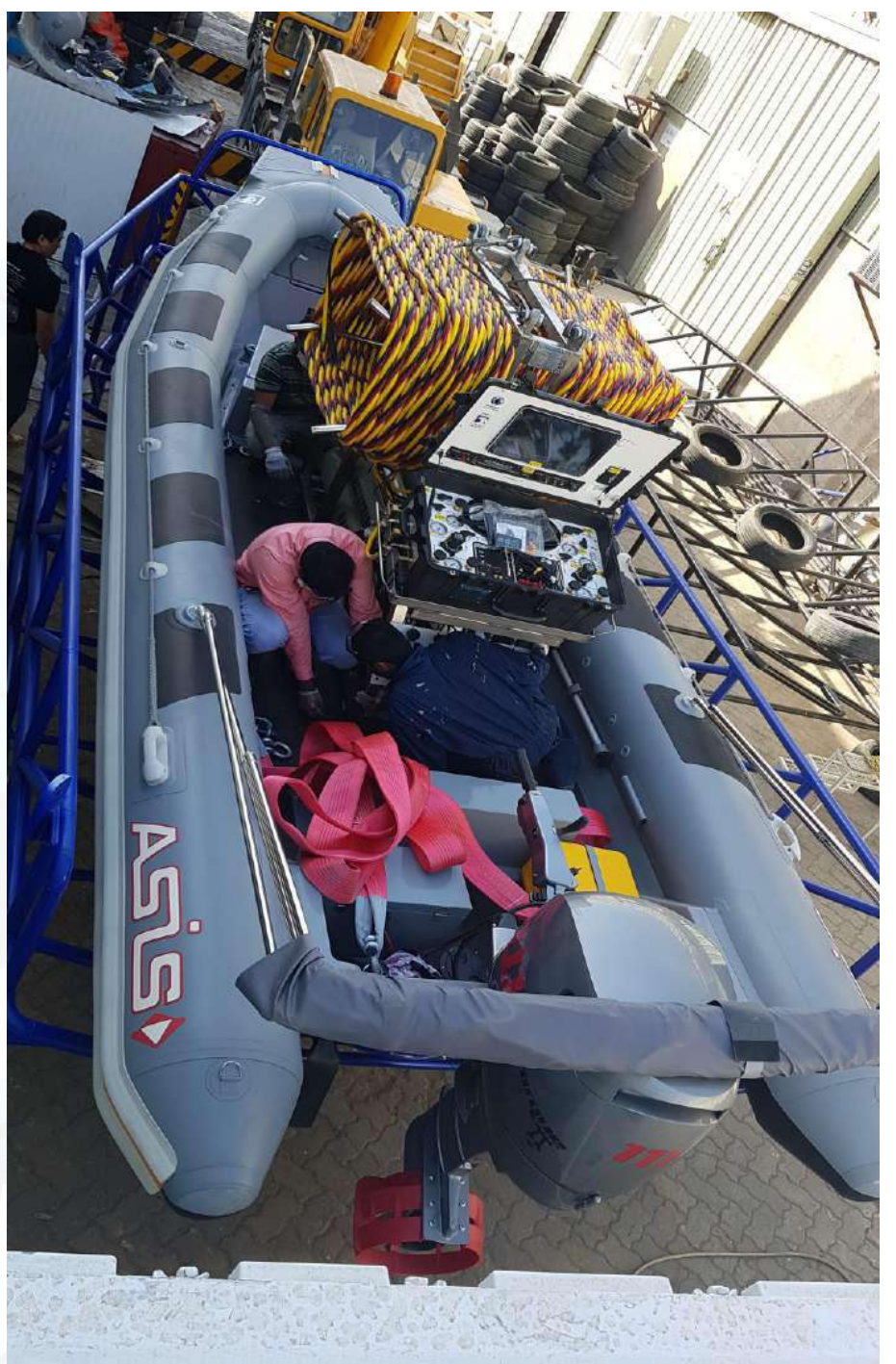
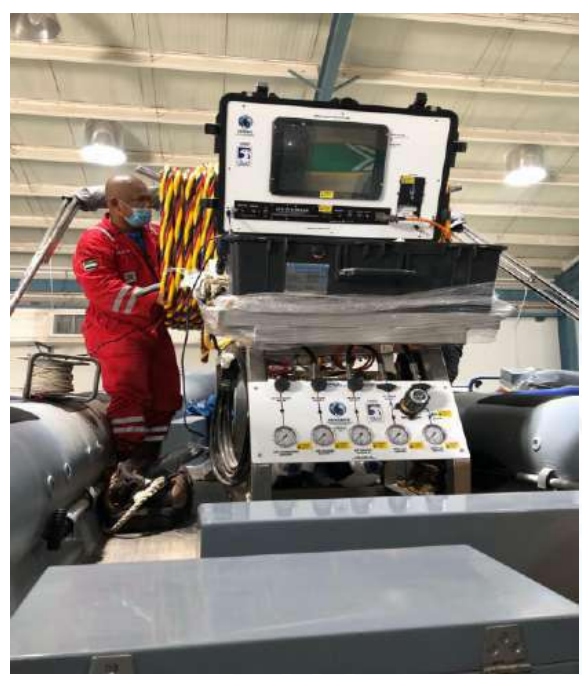

SYNERGY RANGE OF RIGID INFLATABLE BOATS

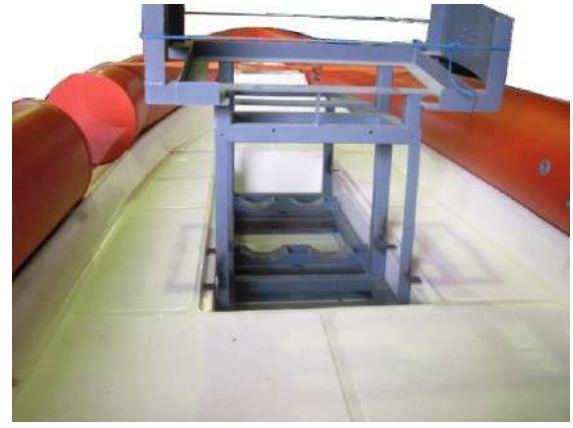

SYNERGY RANGE OF RIGID INFLATABLE BOATS

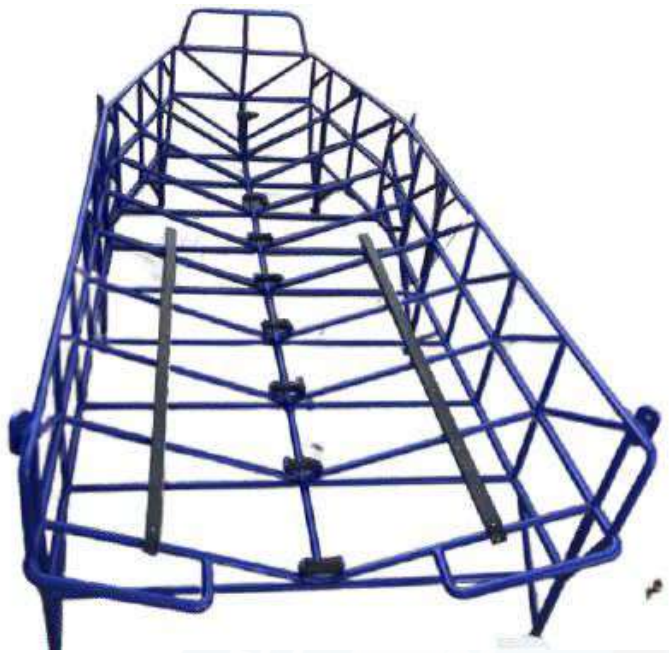

SYNERGY RANGE OF RIGID INFLATABLE BOATS

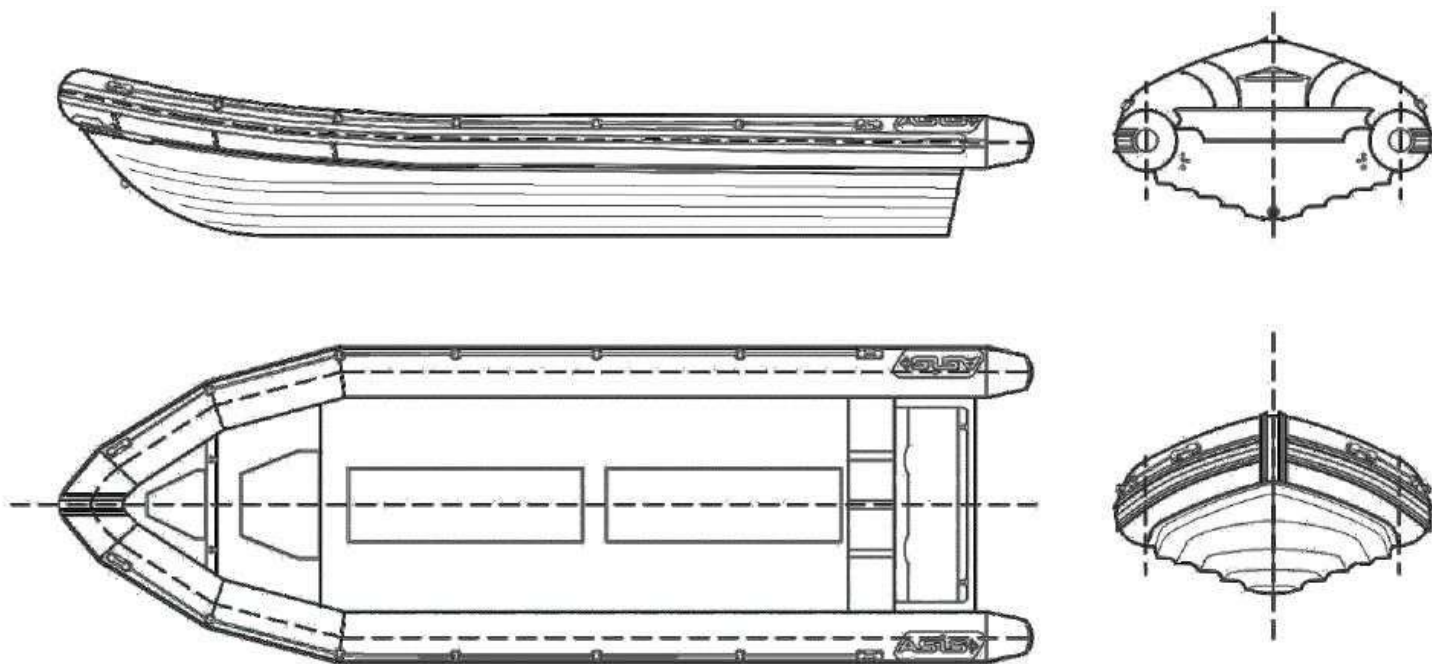

GENERAL	
Hull	GRP or Aluminium
Superstructure	GRP or Aluminium
Collar	Hypalon 1670 Dtex ; Air or Foam
Description	ASIS Customized 12
Classification	Category B
Number of Air Chambers	9 No.

DIMENSIONS	
Length	11900 mm
Beam	3770 mm
Tube Dia	550 mm
Total Weight (Empty Boat)	2500 Kg
Displacement (Maximum Payload)	3720 Kg

CAPACITIES	
Fuel Tank (Maximum Capacity)	1200 L
Fresh Water	Optional
Waste Water	NA
Number of Passenger	25

ELECTRICAL	
Power Supply	12 V Electric Supply
Generator	Optional

PROPULSION	
Recommended Power (HP)	500 HP
Propulsion	Outboard / Inboard
Maximum Power (HP)	900 HP

NAVIGATION & COMMUNICATIONS	
As per the customer's requirements	

SYNERGY RANGE OF RIGID INFLATABLE BOATS

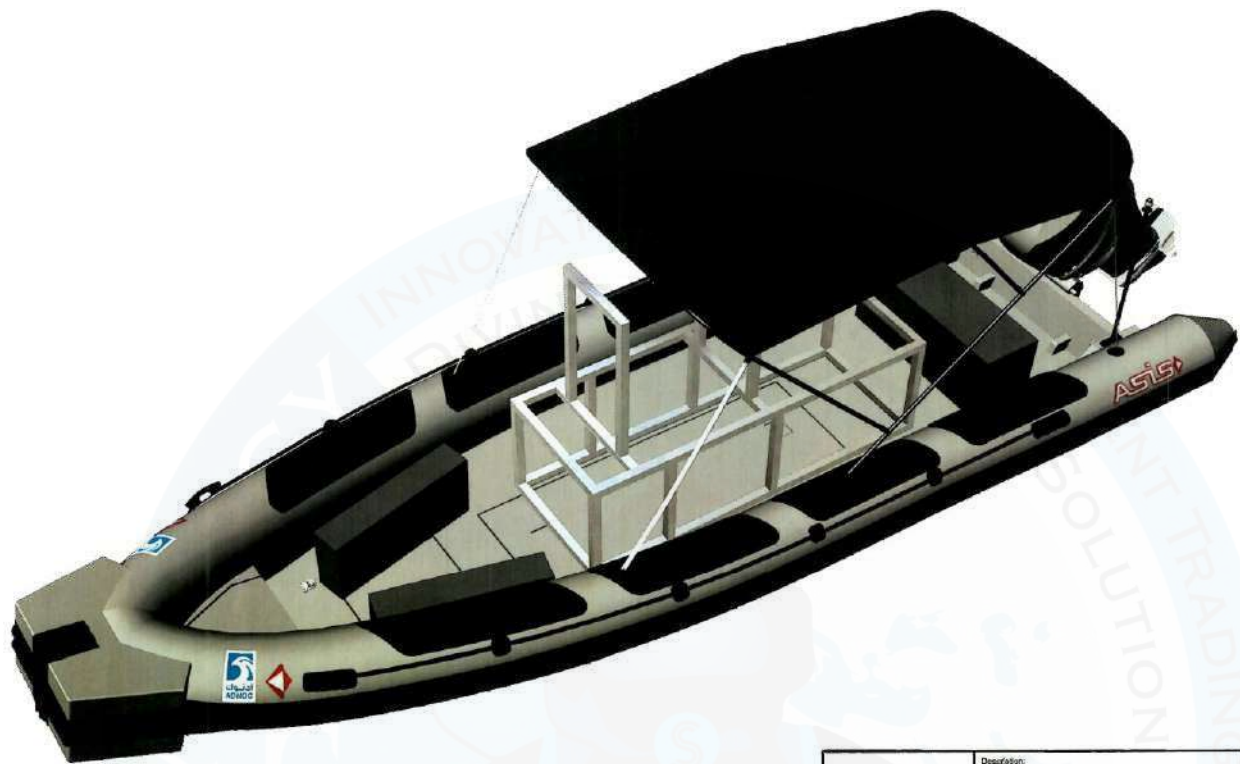

NOTES: -ALL DIMENSIONS ARE IN MM -FOR ILLUSTRATION PURPOSES ONLY	Description: ASIS 7.2m RHIB		
	Scale: NTS	Ref No: 180-	
Date: 18MAR2020	Checked By:	Approved:	



NOTES: -ALL DIMENSIONS ARE IN MM -FOR ILLUSTRATION PURPOSES ONLY	Description: ASIS 7.2m RHIB		
	Scale: NTS	Ref No: 180-	
Date: 18MAR2020	Checked By:	Approved:	

SYNERGY RANGE OF RIGID INFLATABLE BOATS



NOTES: -ALL DIMENSIONS ARE IN MM -FOR ILLUSTRATION PURPOSES ONLY	Description:	ASIS 7.2m RHIB	
	Scale:	NIS	Ref No: (B0-
	Date:	17MAR2020	Checked By: Approved:

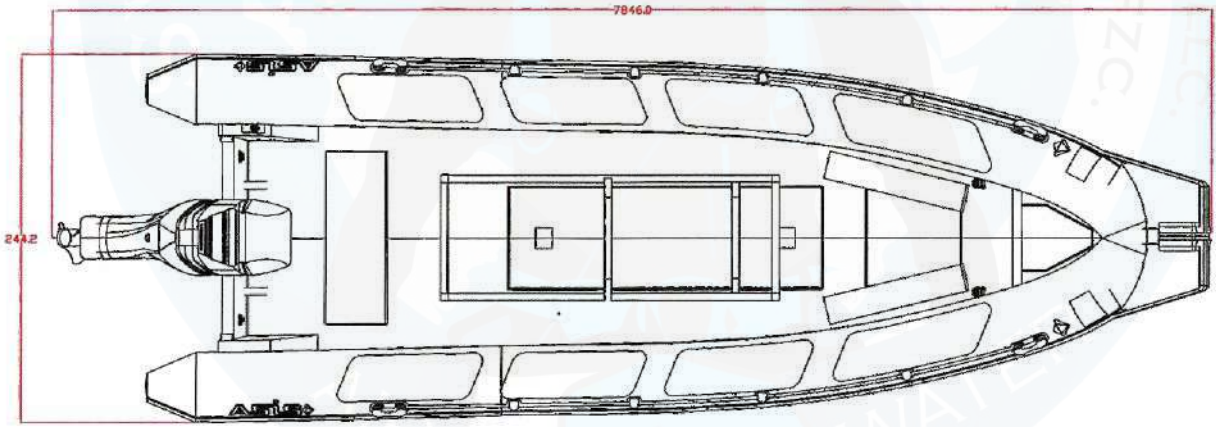

PLAN VIEW

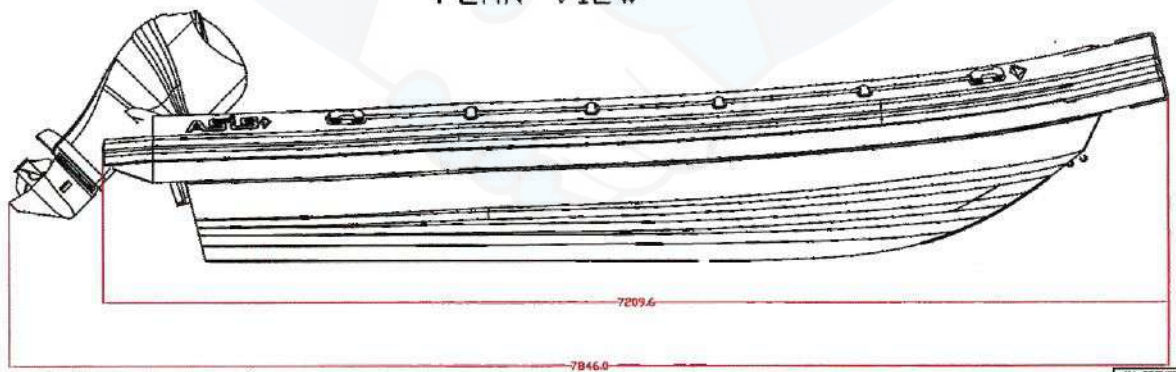

PROFILE VIEW

ALL DIMENSIONS IN MM			
	Created By:	ASIS7.2M RHIB	
	Date:	NIS	Ref No:
Date:	23MAY2020	Checked By:	Approved:

SYNERGY RANGE OF RIGID INFLATABLE BOATS

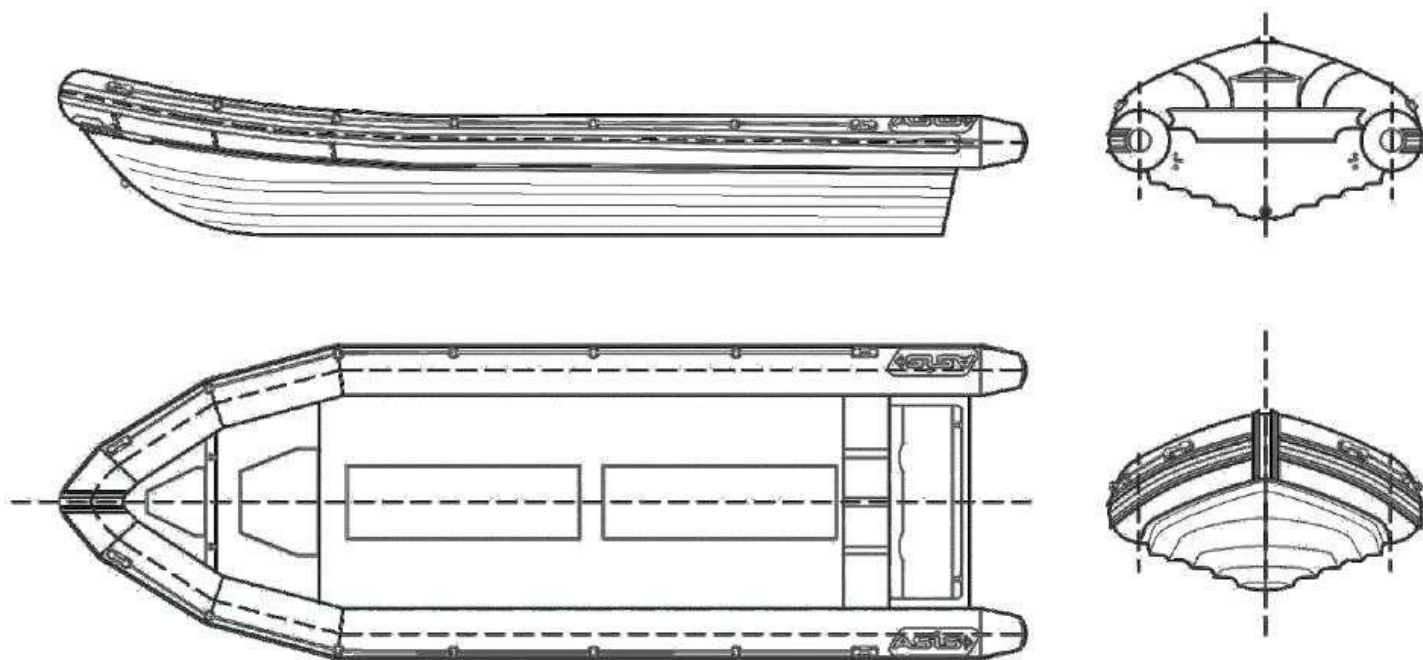

DIMENSIONS	
Overall length	5370mm
Overall Beam	2210mm
Internal Length	4640mm
Internal Beam	1290mm
Weight Empty	448 Kg
Buoyancy Collar diameter	460mm

CAPACITIES	
Max No. of Persons*	7
Max Payload incl. Fuel*	1190 Kg
Floor Board Usable Area	5.4 m ²
Buoyancy Volume	1893 L

SAFETY / INFLATION	
Number of Air Chambers	4 No.
Inflation Pressure	0.24 bar / 3.4 PSI
Intercommunication / Inflation Valves	4 No.4
Pressure Release Valves	No.
Design Category (EC 94/25)	C

ENGINE POWER	
Shaft Length (Single)	20" Standard
Recommended Power	50 Hp
Maximum Power	120 Hp
Maximum Engine Weight	180 Kg

BUOYANCY TUBE	
Fabrics	Hypalon Neopropene 1670 Dtex
Standard Colors	Off-white, Arctic Grey, Dark Blue, Light Blue
Intercommunication and Inflation Valve	4 No.
Safety Valves	4 No.
Internal Chambers	4 No.
Round Rubbing Strake	Triple Rubber Fender Strake All Around the Tube
Grab Rope	Straight Line Rope with Rubber Eyes X 2

SYNERGY RANGE OF RIGID INFLATABLE BOATS

HULL & DECK	
Construction; Fiber Glass Reinforced	Fiber Glass Reinforced Hull & Deck
Deck	Deck with built-in Non Skid Texture
Hull Drains	1 No.
Fuel Tank	90 L
Bilge Pumps	2 No.
Cable Routing	Under Deck Cable Routing Channel

TRANSOM	
Deck Self Drains	2 No.
Transom Thickness	60mm Standard

TOWING & HOISTING	
Bow Towing Ring (S.S U Bolt) on Hull	1 No.
Transom Towing Ring (S.S U Bolts)	2 No.
Lifting Points	4 No.

ACCESSORIES	
Foot Pump	1 No.
Repair Kit	1 No.
Paddles	2 No.

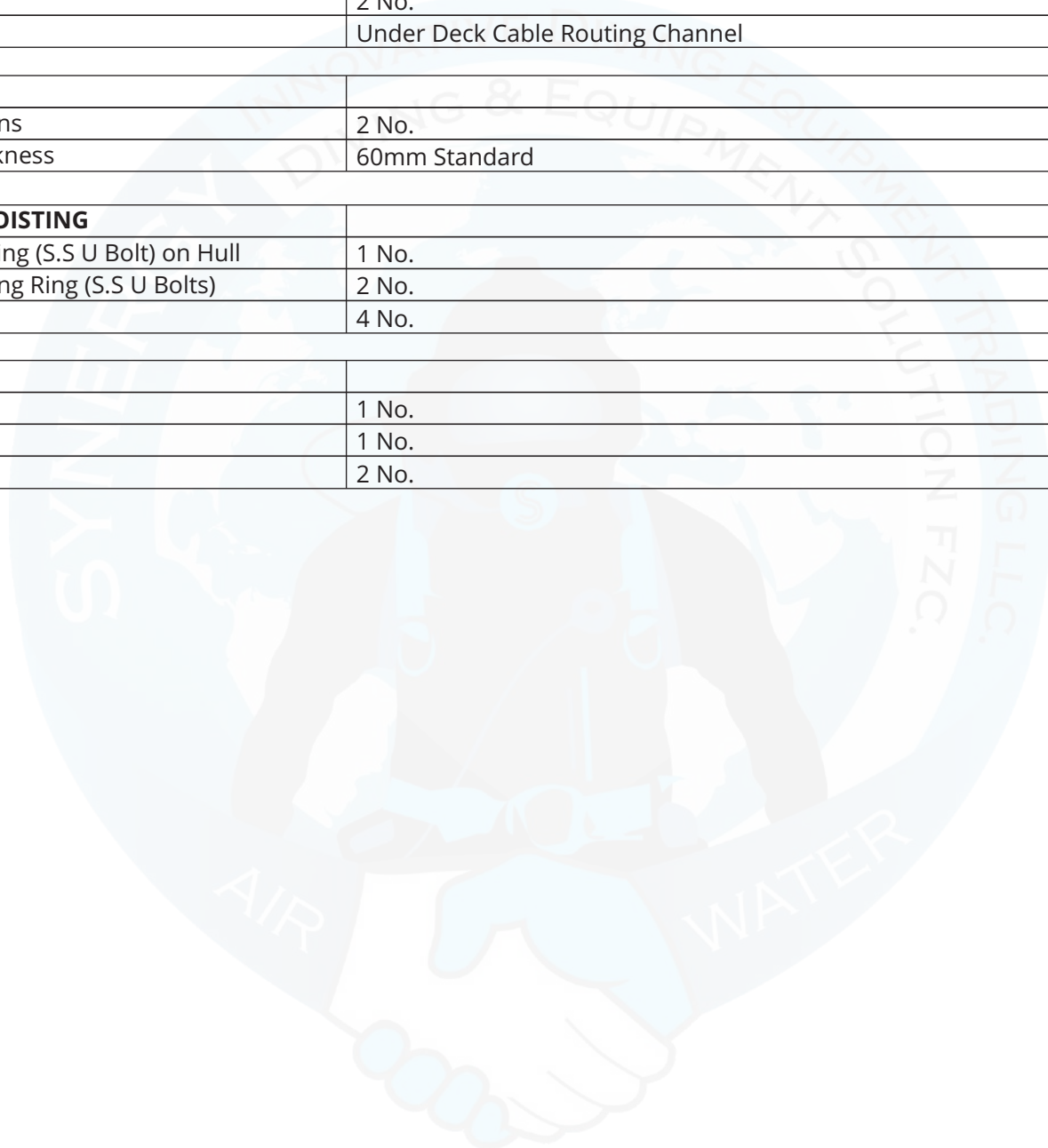

SYNERGY RANGE OF RIGID INFLATABLE BOATS

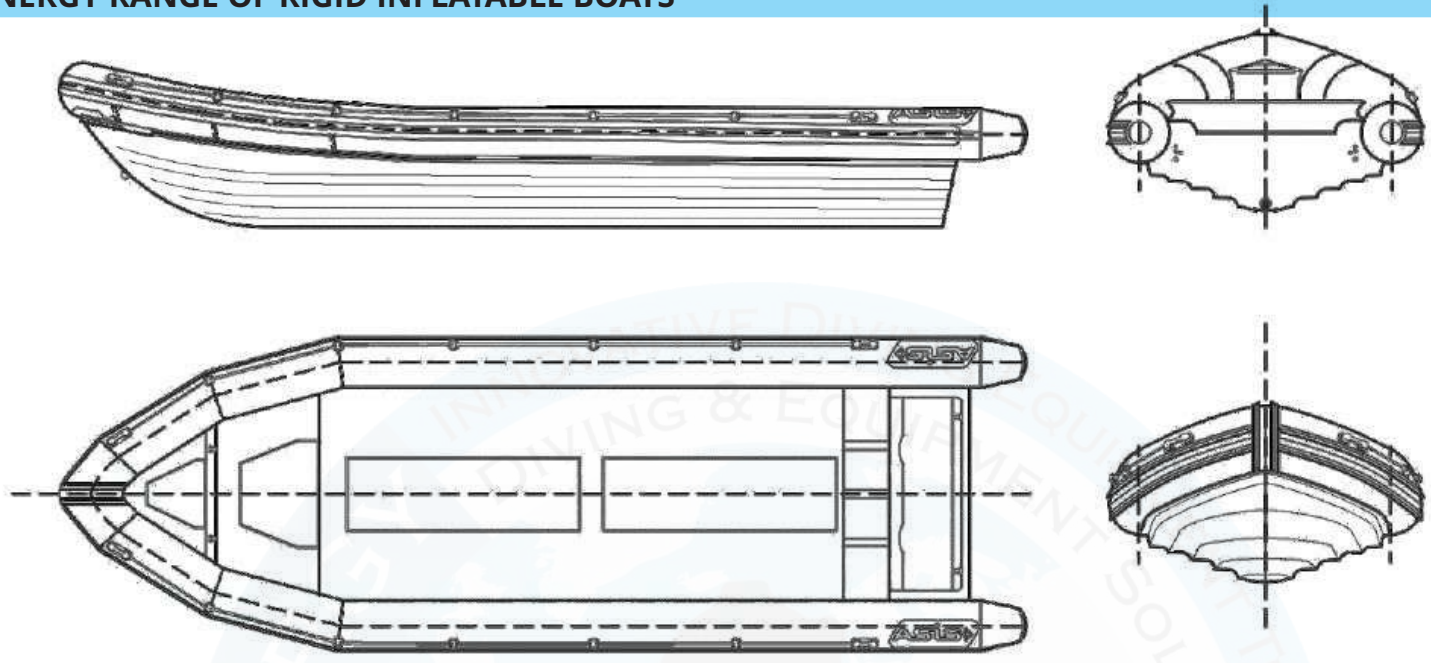

DIMENSIONS	
Overall length	7060mm
Overall Beam	2530mm
Internal Length	6330mm
Internal Beam	1570mm
Weight Empty	756 Kg
Buoyancy Collar diameter	480mm

CAPACITIES	
Max No. of Persons*	10 Persons
Max Payload incl. Fuel*	1870 Kg
Floor Board Usable Area	7.7 m ²
Buoyancy Volume	2605 L

SAFETY / INFLATION	
Number of Air Chambers	5 No.
Inflation Pressure	0.24 bar / 3.4 PSI
Intercommunication / Inflation Valves	5 No.
Pressure Release Valves	5 No.
Design Category (EC 94/25)	C

ENGINE POWER	
Shaft Length (Single)	25" Standard
Recommended Power	115 Hp
Maximum Power	300 Hp
Maximum Engine Weight	288 Kg
Maximum Power With Two Engine (Long Shaft 20)	300 H
Maximum Weight With 2 Engines:	P460 Kg

BUOYANCY TUBE	
Fabrics	Hypalon Neopropene 1670 Dtex
Standard Colors	Off-white, Arctic Grey, Dark Blue, Light Blue
Intercommunication and Inflation Valve	5 No.
Safety Valves	5 No.
Internal Chambers	5 No.
Round Rubbing Strake	Triple Rubber Fender Strake All Around the Tube
Grab Rope	Straight Line Rope with Rubber Eyes X 2



SYNERGY RANGE OF RIGID INFLATABLE BOATS



HULL & DECK	
Construction; Fiber Glass Reinforced	Fiber Glass Reinforced Hull & Deck
Deck	Deck with built-in Non Skid Texture
Hull Drains	1 No.
Fuel Tank	225 L
Bilge Pumps	2 No.
Cable Routing	Under Deck Cable Routing Channel
TRANSOM	
Deck Self Drains	2 No.
Transom Thickness	90mm Standard (60mm Option)
TOWING & HOISTING	
Bow Towing Ring (S.S U Bolt) on Hull	2 No.
Transom Towing Ring (S.S U Bolts)	90mm Standard (60mm Option)
Lifting Points	
ACCESSORIES	
Foot Pump	1 No.
Repair Kit	1 No.
Paddles	2 No.

SYNERGY RANGE OF RIGID INFLATABLE BOATS

Contact us

 29th Street, Amman Road, Behind Al Huraiz Est. For Industry,
Al Qusais, Industrial Area – 1,
Dubai, United Arab Emirates

 Tel : 009714 2580533 

 Fax : 042516664 

 UAE : 00971505648178 

 UK : 00447951966260 

 Website : www.synergiequipment.com

 Email : ram@synergiequipment.com

 For Sale : info@synergiequipment.com

