



# SYNERGY

INNOVATIVE DIVING EQUIPMENT TRADING LLC

INSPIRING • ENGINEERING • INNOVATION



## SY-AQUA ENVIRONMENT REGULATORS



### Ordering Information :

Item # 873-400, 873 High Flow Reducing Regulators

- High Flow Reducing Regulator
- Hand/Spring Loaded
- 1/2 in. NPT outlet
- 1/4 in. NPT inlet
- 0 to 400 psi out

### Specifications

|                                                           |                                                       |
|-----------------------------------------------------------|-------------------------------------------------------|
| Series Designation                                        | 873 Series                                            |
| Type                                                      | High Flow Reducing Regulator                          |
| Hand Loaded/Operated or Dome/Air Operated                 | Hand/Spring Loaded                                    |
| Maximum Rated Pressure                                    | 6000 psi                                              |
| Outlet Pressure Range                                     | 0-400 psi                                             |
| Outlet Pressure Rating                                    | 6000 psi                                              |
| Inlet Port Size                                           | 2 ea 1/4 in. FNPT (One Inlet, One Gauge)              |
| Outlet Port Size                                          | 1 ea 1/4 in. FNPT (Gauge), 1 ea 1/2 in. FNPT (Outlet) |
| Flow Coefficient (Cv)                                     | 0.8 (equals 0.23 in. orifice)                         |
| Outlet Pressure Variations with Inlet Pressure Variations | 10 psi rise/1000 psi inlet drop                       |
| Leakage                                                   | Bubble Tight                                          |
| Weight                                                    | 1300 g                                                |
| Overall Length                                            | 6.5 Inch                                              |
| Round Diameter                                            | 3 Inch                                                |
| Minimum Temperature                                       | -15 °F                                                |
| Body Material                                             | Anodized Aluminum                                     |
| Internal Materials                                        | Anodized Aluminum<br>Brass<br>Stainless               |
| Seal Materials                                            | Kel-F<br>Viton                                        |
| Repair Kit/Service Items                                  | 979-400                                               |
| Accessories                                               | Mount Nuts: P/N 952 (Two Required)                    |



## SY-AQUA ENVIRONMENT REGULATORS



| Specifications                |                                    |
|-------------------------------|------------------------------------|
| Product Using this Repair Kit | 873-400<br>873-400-NA<br>873-400-P |
| Weight                        | 208 g                              |

**Ordering Information :** Item # 979-400, Repair Kit for 873-400 Series Regulator



**Ordering Information :** Item # 873-400, 873 High Flow Reducing Regulators

- High Flow Reducing Regulator
- Hand/Spring Loaded
- 1/2 in. NPT outlet
- 1/4 in. NPT inlet
- 0 to 1000 psi out
- Non-vented

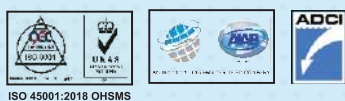

## SY-AQUA ENVIRONMENT REGULATORS

| Specifications                                            |                                                       |
|-----------------------------------------------------------|-------------------------------------------------------|
| Series Designation                                        | 873 Series                                            |
| Type                                                      | High Flow Reducing Regulator                          |
| Hand Loaded/Operated or Dome/Air Operated                 | Hand/Spring Loaded                                    |
| Maximum Rated Pressure                                    | 6000 psi                                              |
| Outlet Pressure Range                                     | 0-1500 psi                                            |
| Outlet Pressure Rating                                    | 6000 psi                                              |
| Inlet Port Size                                           | 2 ea 1/4 in. FNPT (One Inlet, One Gauge)              |
| Outlet Port Size                                          | 1 ea 1/4 in. FNPT (Gauge), 1 ea 1/2 in. FNPT (Outlet) |
| Flow Coefficient (Cv)                                     | 0.8 (equals 0.23 in. orifice)                         |
| Outlet Pressure Variations with Inlet Pressure Variations | 35 psi rise/1000 psi inlet drop                       |
| Leakage                                                   | Bubble Tight                                          |
| Weight                                                    | 1300 g                                                |
| Overall Length                                            | 6.5 Inch                                              |
| Round Diameter                                            | 3 Inch                                                |
| Minimum Temperature                                       | -15 °F                                                |
| Body Material                                             | Anodized Aluminum                                     |
| Internal Materials                                        | Anodized Aluminum<br>Brass<br>Stainless               |
| Seal Materials                                            | Kel-F<br>Viton                                        |
| Repair Kit/Service Items                                  | 979-1500-NV                                           |
| Accessories                                               | Mount Nuts: P/N 952 (Two Required)                    |



### Ordering Information :

Item # 979-400, Repair Kit for 873-400 Series Regulator

| Specifications                |                                                |
|-------------------------------|------------------------------------------------|
| Product Using this Repair Kit | 873-1500-NV<br>873-1500-NV-NA<br>873-1500-NV-P |
| Weight                        | 224 g                                          |

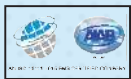

# SY-AQUA ENVIRONMENT REGULATORS



## 6000 PSI HIGH FLOW REDUCING REGULATOR MODEL 873

### GENERAL INFORMATION

The model 873 is a piston type hand loading regulator. It utilizes a balanced poppet design for high flow and minimum effect of inlet pressure on outlet pressure. The poppet assembly is contained in a cartridge with internal filtration permitting very easy in field servicing. The low cost poppet cartridge (pictured on the opposite side of this sheet) is factory preassembled. It contains the more critical valving elements of the regulator thus eliminating in-field servicing problems. The regulator is self venting but is optionally available without the vent. This regulator design was developed for gas mixers for commercial diving where high flow, very precise pressure control and high reliability are needed. They have served this application for many years. It is available with different size sensing pistons resulting in a complete range of outlet pressures. A highly sensitive dome loaded version rated to 6000 PSI is also available.

### TECHNICAL SPECIFICATIONS

- Maximum inlet pressure 6000 PSI (40 MPa)
- Outlet pressure - from 0 to:
  - model 873-150..... 150 PSI
  - model 873-400..... 400 PSI
  - model 873-1500..... 1500 PSI
  - model 873-5000..... 5000 PSI
  - model 873-D..... 6000 PSI
- Flow coefficient (C<sub>v</sub>)..... 0.8 (0.23" orifice)
- Rise of outlet pressure with drop of inlet pressure..... 1 PSI per 1000 PSI for model 873-150
- Materials ..... body and cap - aluminum  
 internals - brass, stainless  
 seals - Buna N, nylon
- Fittings ..... 1/2" NPT outlet port  
 1/4" NPT inlet & gauge ports
- Size ..... 3 inch dia. x 5 inch long

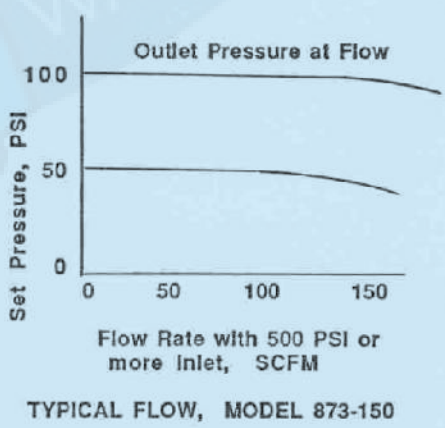

**Aqua Environment Inc.**  
 PO Box 935, Stinson Beach, CA. 94970, (415) 453 8157

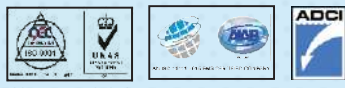

## SY-AQUA ENVIRONMENT REGULATORS

### TYPICAL APPLICATIONS

- Operation of high flow, low pressure equipment such as sirens from high pressure air tanks. Here use of high pressure air eliminates dependency on electrical power in an emergency.
- Component testing
- Air tank fill stations
- Fire fighting air systems
- Instrumentation and calibration panels
- Process industry control
- Shipboard and off shore air and gas control
- Aircraft service equipment
- Electronic industry rare gas flow
- Vehicle CNG stations
- Precision gas mixing equipment

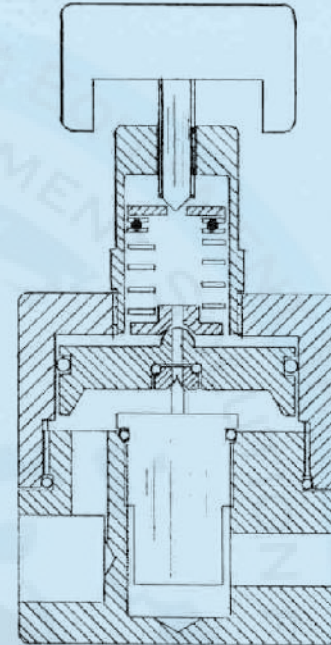

0 to 150 PSI model

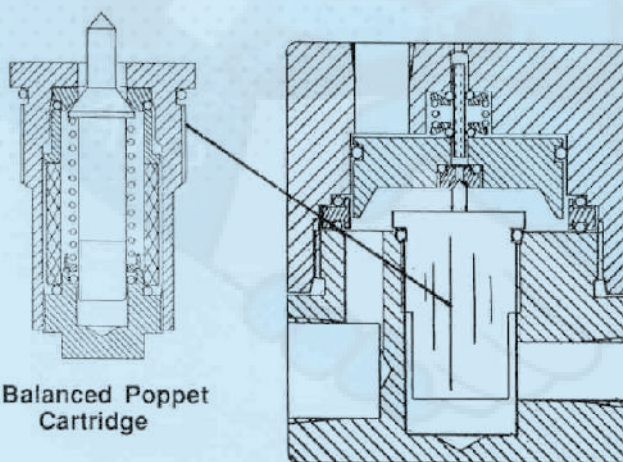

Balanced Poppet Cartridge

Dome Loader model

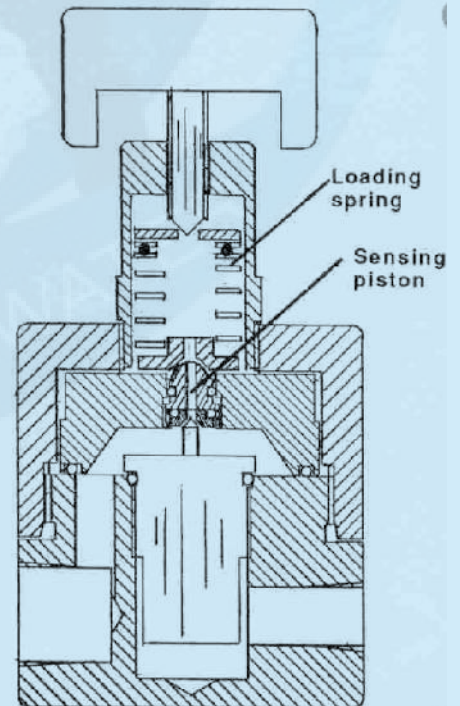

0 to 5000 PSI model

## SYNERGY INFRASTRUCTURE





# SYNERGY

INNOVATIVE DIVING EQUIPMENT TRADING LLC

INSPIRING • ENGINEERING • INNOVATION

UAE • UK











ISO 45001:2018 OHSMS





## SY-AQUA ENVIRONMENT REGULATORS

### Contact us

 P.O. Box – 237849, Warehouse No 8,  
Al Maidoor Warehouse, Al Qusais,  
Industrial Area - Dubai - UAE

-  Tel : 009714 2580533 
-  Fax : 009714 2580534 
-  UAE : 00971505648178 
-  UK : 00447951966260 

-  Website : [www.synergiequipment.com](http://www.synergiequipment.com)
-  Email : [ram@synergiequipment.com](mailto:ram@synergiequipment.com)
-  For Sale : [info@synergiequipment.com](mailto:info@synergiequipment.com)



SYNERGY  
INNOVATIVE DIVING & EQUIPMENT TRADING LLC  
INSPIRING • ENGINEERING • INNOVATION

# CORE TEAM



SYNERGY TEAMWORK MAKES THE DREAM WORK

